



# **How to Attach Butler Robotics to an APQS**

## **APQS Original Carriage**

**In order to accommodate all machine types we use universal parts bags, not all parts will be used in every installation.**

**Bag #**

**Contents**

**Picture**

**X1**

1-White belt (12')  
4 - Plastic belt clamps  
4 - Screws (4-40 x 0.5)



**Y1**

1 - Black belt (86")  
4 - Plastic belt clamps  
4 - Screws (4-40 x 0.5)



**Z1**

1- Stylus  
5 - Zip ties  
5 - Plastic anchor  
2 - Washer (M5 Flat)  
2 - Screws(M5 x 12mm)



**Z3**

1 - Motor pulley cover  
2 - Nut (M5 K-Lock)



**D3  
or  
D6**

1 - Universal display bracket  
4 - Screw (M6 x 8mm)  
4 - Nut (M6)  
2 - Screw (8-32 x 0.5)  
2 - Plastic washer



## Bag #

## Contents

## Picture

### Cables

Vary by machine



### X8

2 - L -bracket  
2 - Slotted bracket  
2 - Eye bolt (M5)  
2 - Nut (M5 K-Lock)  
2 - Screw (10-24 x 0.5)  
2 - Nut (10-24 K-Lock)



### Or X10

2- Clamp bracket side A  
2- Clamp bracket side B  
2- Eye bolt (M5 x 40mm)  
4- Round head screw  
(1/4-20 x 2")  
4- Hex nut (M5)



### M10

1-Motor box bracket  
2- Mounting bracket clamp  
4- Pan head screw (1/4-20 x 1/2")  
2- Pan head screw (#8-32 x 1/2")  
2- Pan head screw (M5 x 1/2")

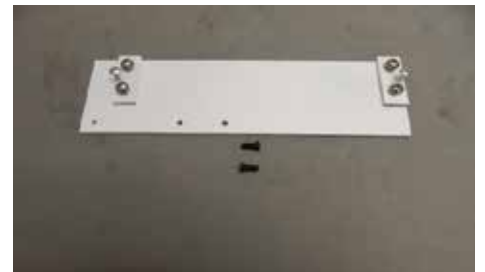

### Y14

1- Carriage bracket  
1- Eye bolt (M5 x 40)  
2- Hex nut (M5)  
1- Pan head screw (10-24 x 1/4")  
2- Pan head screw (#10-24 x 1/2")  
1- Universal Y-bracket  
2- Flat washer (#10)  
1- Thumb screw (#10-24 x 1/2")



### I10

1- Rear idler bracket  
2- Fender washer (#10-5/8")  
2- Mounting bracket clamp  
1- Nylon spacer (1/2" x 1/4")  
1- Pan head screw (#10-24 x 1")  
2- Pan head screw (#8-32 x 1/2")  
4- Pan head screw (1/4-20 x 1/2")  
2- Lock washer (#10)



## Attach the Motor Bracket (Bag M10)

**1** Use the clamps to attach the motor bracket to the front of the frame.

Use the clamps to attach the bracket to the sides of the carriage rails.

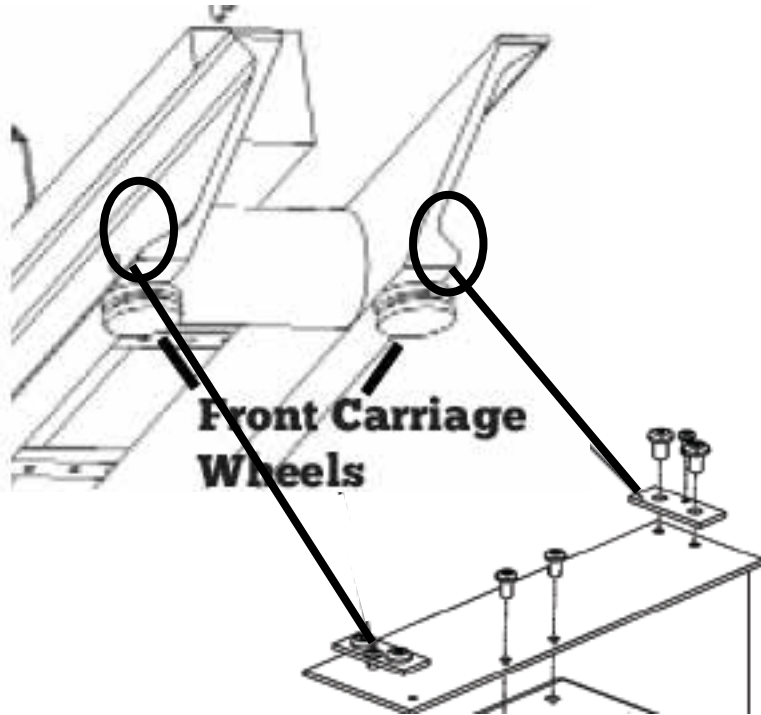

**2** Use the provided screws to attach the motor box to the motor bracket.

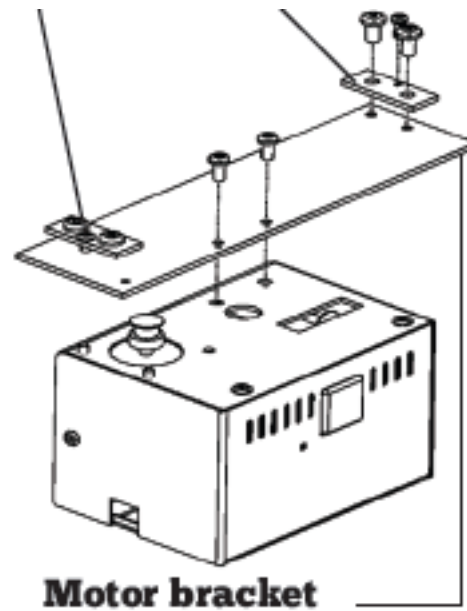

## Attach the Rear Idler Bracket (Bag I10)

- 1 Use the clamps to attach the rear idler bracket to the rear of the frame with the pulley on the same side as the motor box pulley.



Use the clamps to attach the bracket to the sides of the carriage rails like the motor bracket.



## Attach the Carriage Bracket (Bag Y14)

- 1 Locate the two holes on the bottom of the machine near the center.



- 2** Use the provided screws to attach the carriage bracket to the holes on the bottom of the machine.



- 3** Use a belt clamp to attach the black belt to the carriage bracket with the teeth facing the machine.

*See Appendix A*



- 4** Loop the belt around the rear idler pulley and up around the pulley on the motor box. Make sure the teeth are facing in.



- 5** Use another belt clamp to attach the belt to the eye bolt on the carriage bracket.

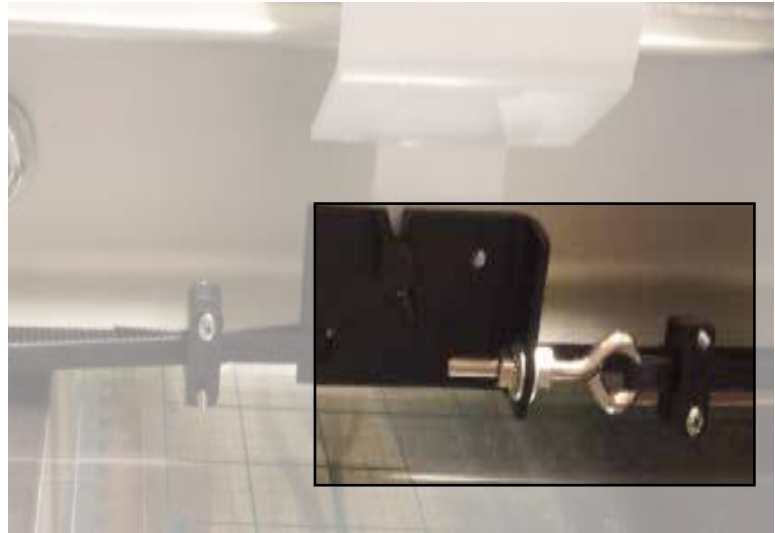

- 6** Adjust tension as needed. The belt should have about 1/4" of play.

## **Installing the White Belt (Bag X8 or Bag X10)**

Continue to page 10 for round tube frames

## **Installing the White Belt Round Tube Frame (Bag X10)**

- 1** Insert the eye bolt into the middle hole of the inner belt bracket.





**2** Clamp the belt brackets to the frame in such a way that the eye bolt will be in-line with the pulley on the back of the motor box.

Repeat for both sides.

*For round tube frames see page 9.*

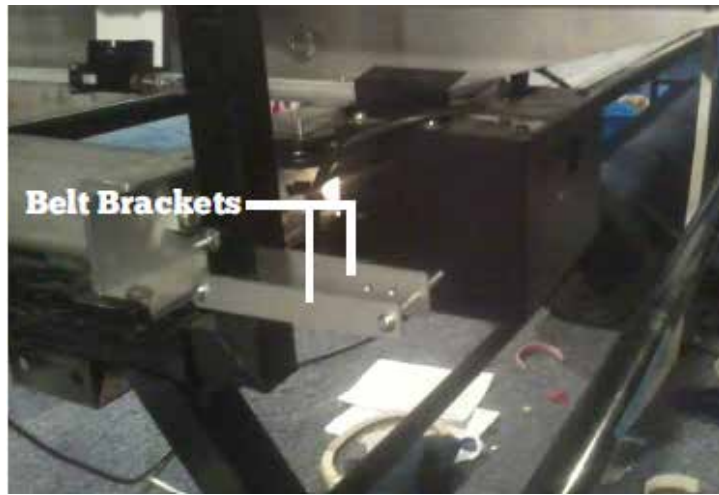

\*Two possible configurations displayed



**3** Use the belt clamps to attach the belt to an eye bolt.

*See Appendix A for belt clamp instructions.*





- 4** Release the belt lock lever and run the belt as shown with the teeth facing up.

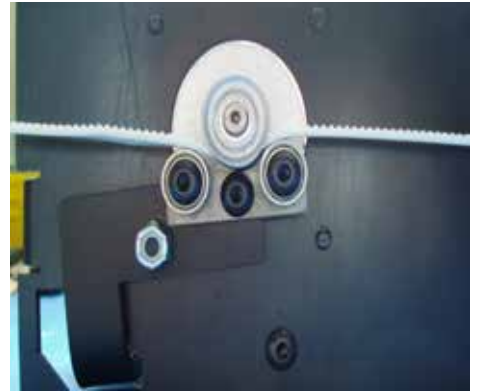

- 5** Use the belt clamps to attach to the eye bolt on the other side.
- Reengage the lock lever on the motor box.



- 6** Adjust tension as needed. The belt should have about 1/2" of play with the motor box in the middle of the frame.

## Installing the White Belt Round Tube Frame (Bag X8)

- 1** Remove the U-channel screw from the frame.

Attach the bracket mount to the frame with the U-channel screw.

Use the provided screws to attach the L bracket as shown.

Repeat for both sides.

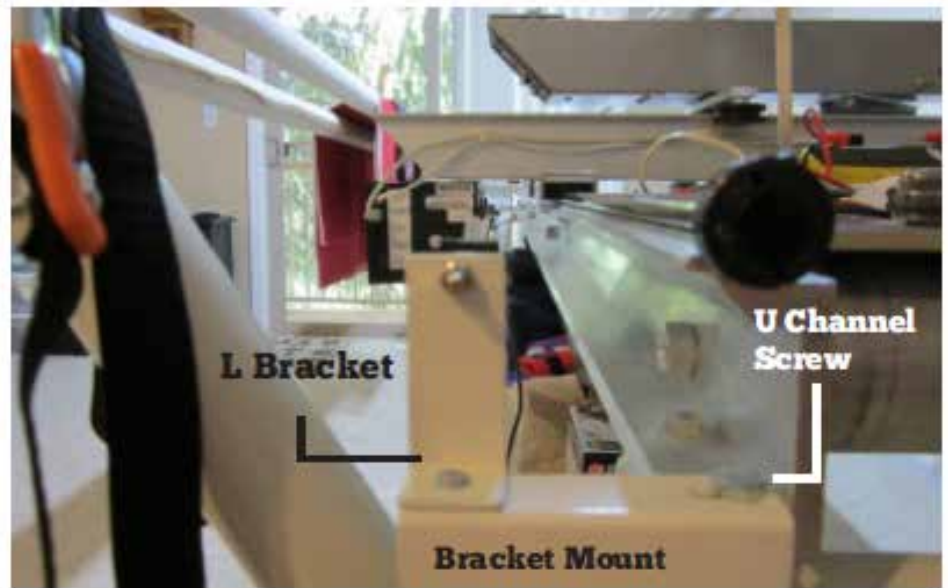

- 2** Attach the eye bolt to the top hole on the L-bracket

Repeat for both sides.



- 3** Use the belt clamps to attach the belt to an eye bolt.

See Appendix A for belt clamp instructions.

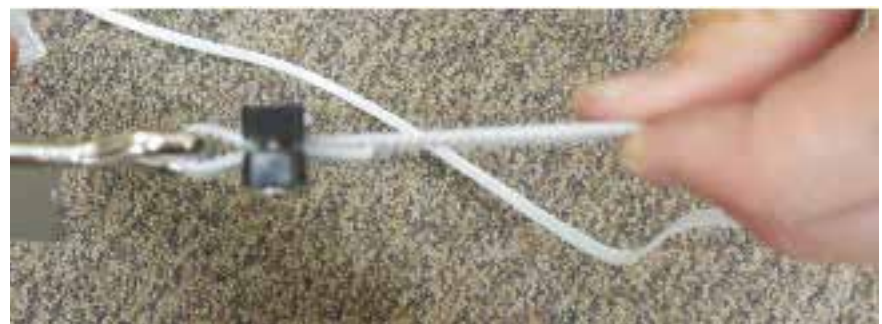

- 4** Release the belt lock lever and run the belt as shown with the teeth facing up.

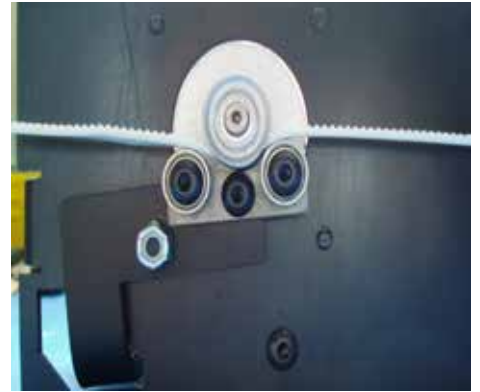

- 5** Use the belt clamps to attach to the eye bolt on the other side.
- Reengage the lock lever on the motor box.



- 6** Adjust tension as needed. The belt should have about 1/2" of play with the motor box in the middle of the frame.

## Installing the Android Display Bracket (Bag D3)

- 1** Remove the two screws on the top front of the machine.



- 2** Use the removed screws to attach the display bracket to the machine as pictured.



- 3 Attach the display holder to the remote bases on the display bracket with the poly disc in between.



**For information on how to install the Android display, Please refer to the *Installing/Troubleshooting your Android Tablet* guide.**



## Installing the Standard Display Bracket (Bag D6)

- 1** Attach the display to the bracket with the four provided screws.

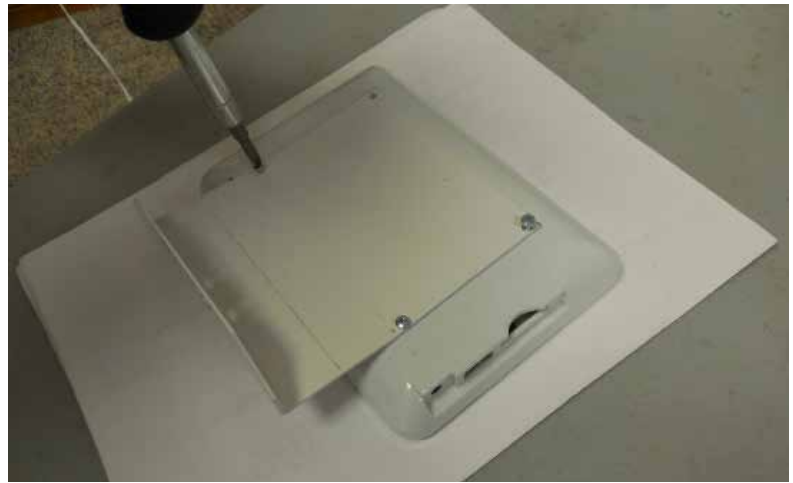

- 2** Remove the two screws on the top front of the machine.



- 3** Use the removed screws to attach the display bracket to the machine as pictured.



- 4** Plug in the display cable into the remote display.

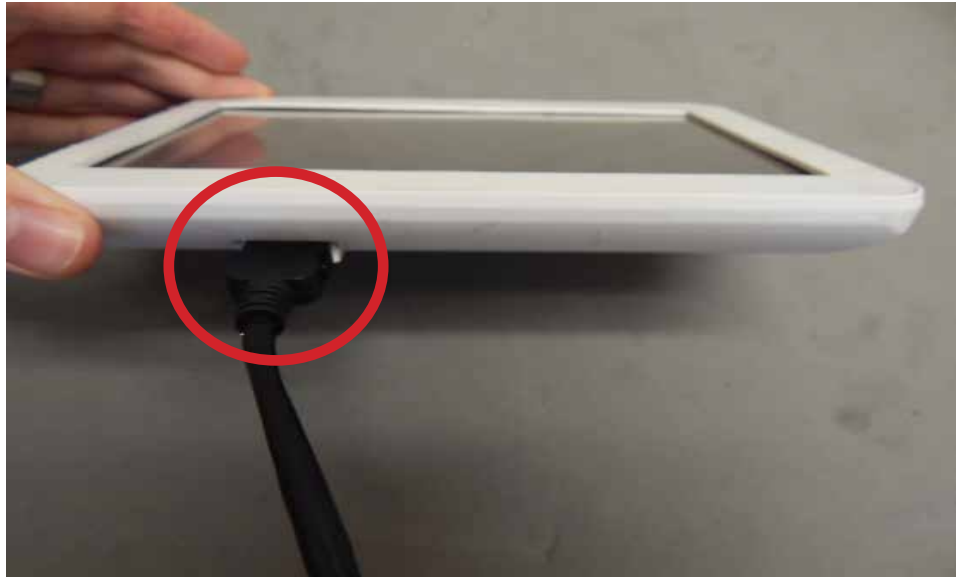

- 5** Run the display cable as pictured using the provided adhesive anchors and zip-ties.

**Do not zip-tie the bottom anchors at this point.**

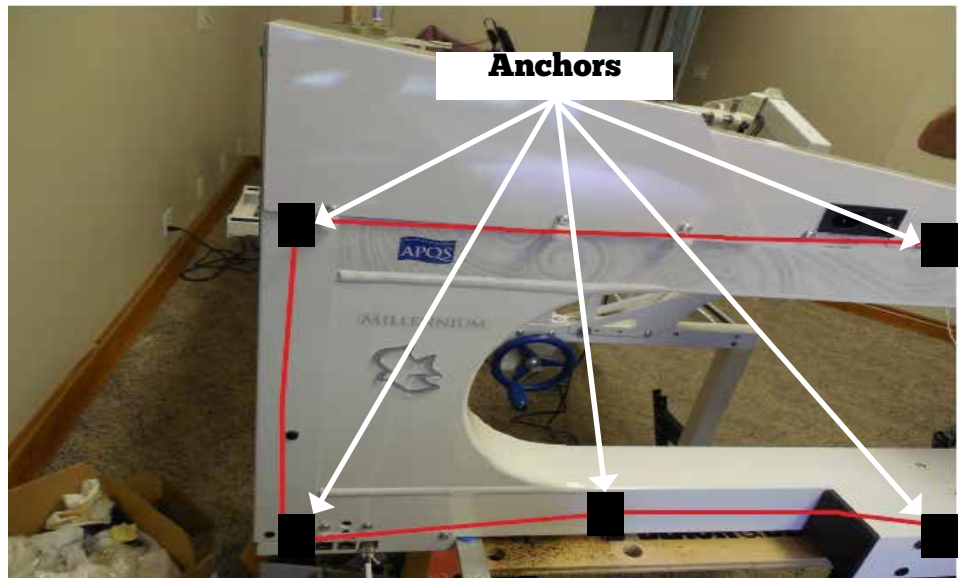

- 6** Plug the other end of the display cable into the remote port on the black motor box.





## Connect the Handlebars

For models with AUX port, for models without continue to page 17

- 1 Plug the handlebar cable into the auxiliary port, labeled AUX, at the rear of the machine.



- 2 Run the handlebar cable to black motor box along side the display cable.

Zip-tie both together to the anchors.



**3** Run the handlebar cable to black motor box along side the display cable.

Zip-tie both together to the anchors.



**For models without AUX port**

**1** Locate and disconnect the two rear handlebar cables.

*Some machines will have the wires plugged directly into the back of the machine.*



**2** Connect the included Y-cable into the rear handlebars.

The Y-cable is labeled left and right as if standing at the back of the machine.

Repeat for both sides.



**3** Plug the remaining end of the Y-cable into the stitcher box.

Mount the stitcher box to the rear of the machine with the double-sided tape



**4** Plug one end of the network style cable into the Motor Box port on the stitcher box.



**5** Run the network style cable with the display cable to the motor box.

Zip-tie both together to the anchors.



**6** Plug the other end into the Stitcher Box port on the black motor box.





# Set Machine Type

If you have a QuiltEZ Perfect Stitch Regulator, then set your machine type to Default.

## 7" Tablet:

**1** Power on the display, go to **Home > Setup**

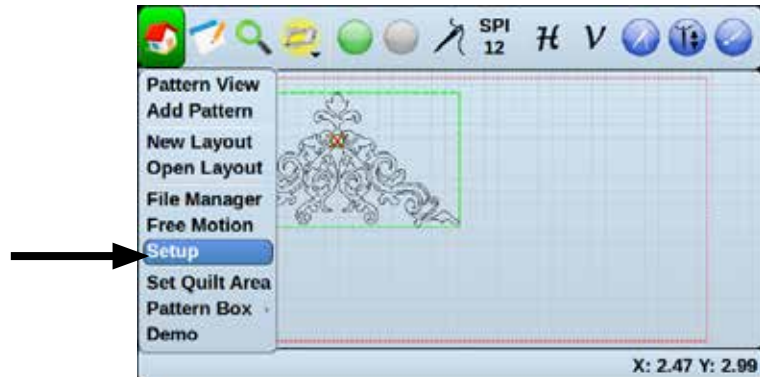

**2** Go to the **Advanced**  
Select Machine Type.

See next page to determine machine type settings.



## 10" Android Tablet:

**1** Power on the display, go to **Settings > Advanced** tab.

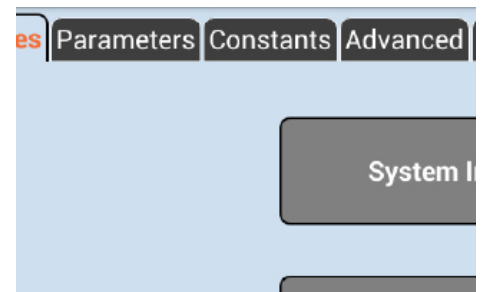
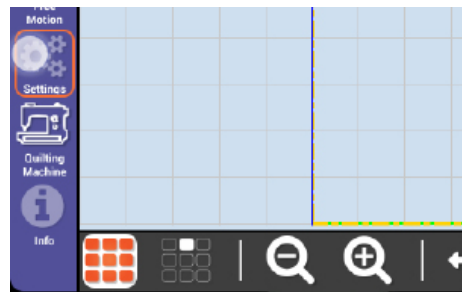

Select Machine Type.

**2** See next page to determine machine type settings.

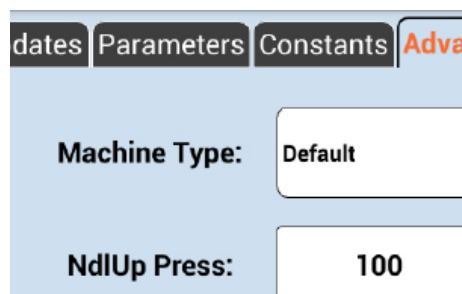

## Which Machine Type?

*Pre “AUX Port” Model*

Select Machine Type and set the machine type to APQS Pre-09.

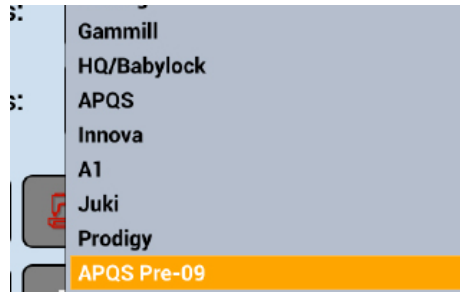

*“AUX Port” Model*

Select Machine Type and set the machine type to APQS.

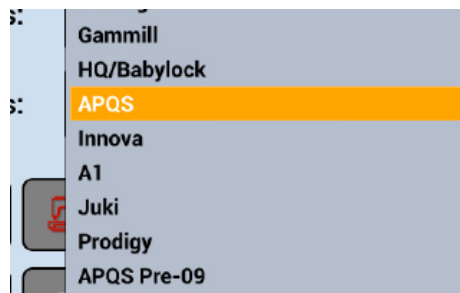

## Check Belt Tension

- 1** A correctly tensioned belt won't be as tight as a piano string but not sagging either. Aim for a taught belt.

Adjust belts as necessary.

# Motor Pulley Cover (Optional)

- 1** Place cover onto two screws near the top motor box pulley.

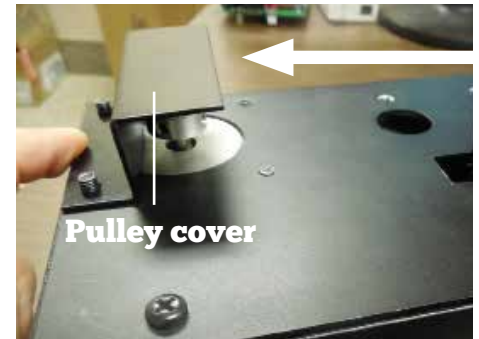

Tighten nuts onto top of screws to secure the Pulley cover.

(Refer to **Bag #28**)

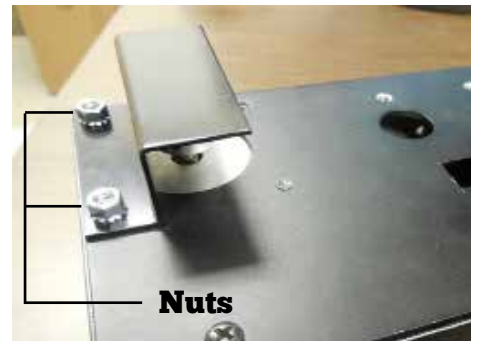
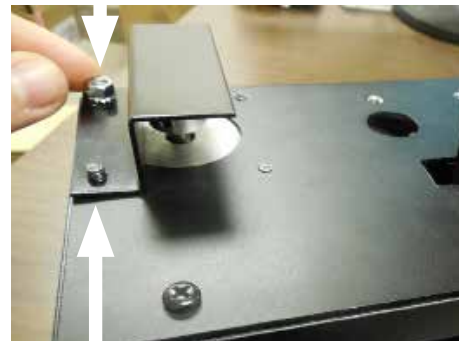

## What is the Pulley Cover for?

The Motor Pulley cover is an extra safety precaution to protect your fingers from getting entangled in the belt.

We recommend it is installed after all your belts are installed and connected to the pulleys.



## Appendix A - How to use Belt Clamps

A belt clamp consists of two clamps and two screws.



- 1** Using a Phillips screwdriver, insert each screw on opposite sides of the clamps and tighten halfway.

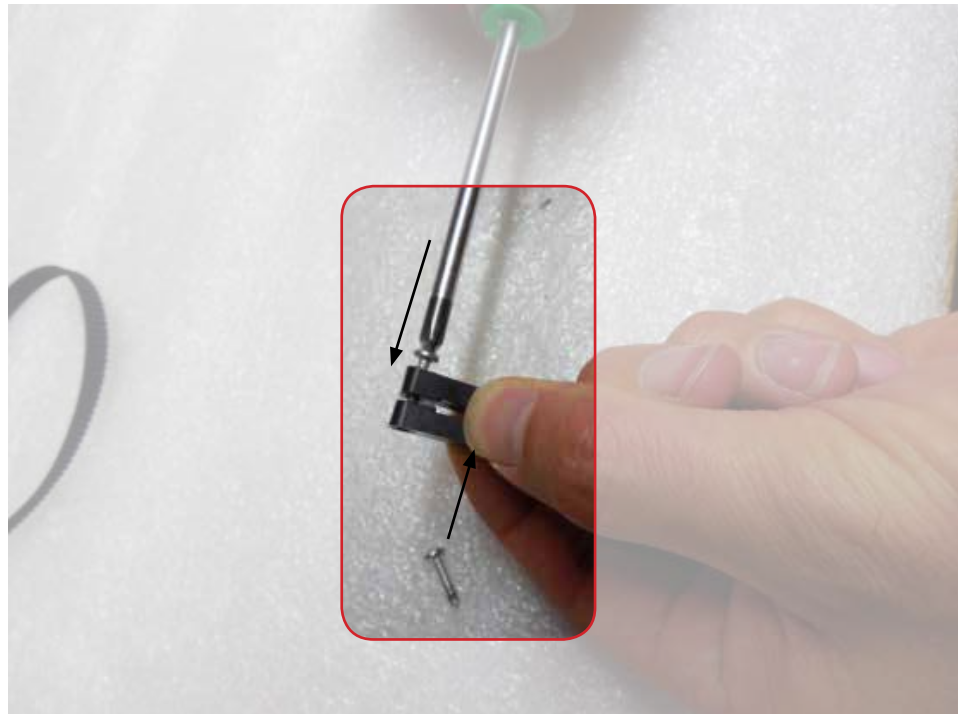

- 2** Thread the belt between the clamps, loop it around and reinsert it between the clamps.



- 3** Align the belt teeth, then finish tightening the clamps.



# Appendix B- Additional help

## Installing cables

Please refer to the Connecting Robot to Quilt Machine instruction set for help installing cables.

## Power on the robotics

Use the power switch located on the side of the motor box with the ports to power the motor box off and on.

## Disengage belts for free motion

In order to use free motion with the butler connected the belts will need to be disengaged.

To disengage the x-belt, move the locking lever away from the edge of the motor box.

To disengage the y-belt, loosen the wing-nut on the carriage bracket.

You can now use free motion quilting.

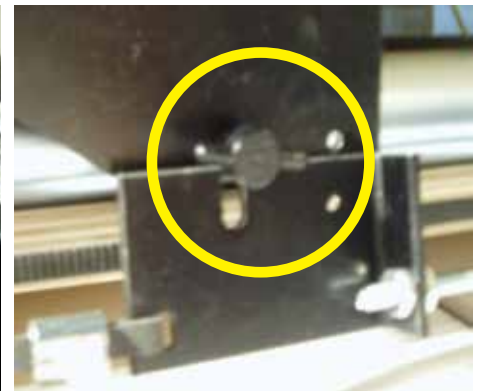



**Still need help?**

Visit [support.quiltez.com](http://support.quiltez.com) for  
tutorial videos and additional  
help documentation